

200 Watt — PYG200W V3.0

Constant current&constant voltage LED driver with 0-10V or PWM dimming

Product family features



- Drive Mode: Constant Current, Constant Voltage, Dimming
- Technology: Active PFC Corrected 2-Stage Switch Mode
- Input Voltage: 100 to 277Vac (UL). 100 to 240Vac (ENEC)
- Output Power: 200Watt Max
- Dimming: Smooth & Continuous Dimming from 10% to 100%. LEDs turn on to any dimmed level without going to full brightness.
Constant Current Reduction (CCR) dimming methods.
0-10V: 2-wire Analog / PWM Control Dimming (Isolated from AC&DC)
- Efficiency: Up to 93%
- Warranty: 5 years
- Continuous, flicker-free dimming from 10% to 100%, Set maximum output current, Set minimum dim
- The programming cable and the dimming cable are combined to simplify the user's operation
- Three time controlled dimming modes
- Safety isolation between primary and secondary. Dimming control is isolated from AC input and DC output
- A rated lifetime of 50,000 hours @ Tc = 80°C
- Safety: UL8750, Class P, CSA22.2, EN61347, GB19510
- EMC: FCC 47CFR Part 15, Class B @120V & Class A @277V, EN55015, GB17625
- Inrush Current Limiting Circuitry: AC Power Line: line to line 6KV, line to earth 10KV eliminates circuit breaker tripping, switch arcing and relay failure
- Metal shell, Used with silicone potting. Meet the RoHS directive
- IP67, NEMA4 compliant for Dry, Damp, Wet Locations. Type HL



Product datasheet

Technical data

Electrical data

200W 0-10V & PWM Dimming or Constant Current Part List (Programmable)

Product Model	US & CN Class 2	Output Voltage Range(Vdc)	Programmable Current Range (mA)	Programmable Current / Voltage Range at Full Power Output (mA / Vdc)	Typical Current at Full Power Output (mA)	Efficiency% @ Max Load				Uout max (V)
						Vout(V)	@120V	@230	@277	
PYG200W-56-C5600-RP-P-W	No	28-56	700-5600	5600 – 3600 36 – 56	5600, 4200, 3600	36	90.7	91.5	92.5	59
PYG200W-150-C2100-RP-P-W	No	75-150	500-2100	2100 – 1330 90 – 150	2080, 1750, 1400	90	92.1	93.3	93.4	160
PYG200W-286-C1100-RP-P-W	No	143-286	350-1100	1100 – 700 182 – 286	1050, 910, 800, 700	182	92.1	93.5	93.6	300
PYG200W-56-C5600-RP-P	No	28-56	700-5600	5600 – 3600 36 – 56	5600, 4200, 3600	36	90.7	91.5	92.5	59
PYG200W-150-C2100-RP-P	No	75-150	500-2100	2100 – 1330 90 – 150	2080, 1750, 1400	90	92.1	93.3	93.4	160
PYG200W-286-C1100-RP-P	No	143-286	350-1100	1100 – 700 182 – 286	1050, 910, 800, 700	182	92.1	93.5	93.6	300

Note: Maximum efficiency measured at 230VAC input

Product may be suffixed by "-P", which means suitable for UL listed & class P models, without suffix "-P" are suitable UL component use only

Product may be suffixed by "-W", which means suitable for EU or UL wet location use models, without suffix "-W" are suitable dry/damp location use only

Electrical Specifications

	Parameter	Min	Typ	Max	Notes / Conditions	
Input	Input Voltage	90V		305V		
	Input Frequency	47Hz	50/60Hz	63Hz		
	Input AC Current				2.05A	Measured at 120 Vac / 60Hz Input, Output Full Load
					1.15A	Measured at 230 Vac / 50Hz Input, Output Full Load
					0.98A	Measured at 277 Vac / 60Hz Input, Output Full Load
	Inrush Current (Peak)			62A / 3us	67A / 4us	Measured at 120 Vac / 60Hz Input, Output Full Load
				135A / 3us	140A / 4us	Measured at 277 Vac / 60Hz Input, Output Full Load
Leakage Current				400μA	Measured at 120 Vac / 60Hz Input, Output Full Load	
				750μA	Measured at 277 Vac / 60Hz Input, Output Full Load	
THD				20%	Measured at 120, 230, 277 Vac Input, Output ≥ 60% Load	
Power Factor (PF)	0.90					
Output	DC Output Voltage	Per Table	Per Table	Per Table	Per Tables on Page 1,2	
	Output Constant Current	-5%	Per Table	+5%	Per Tables on Page 1,2	
	Output Power			Per Table	Per Tables on Page 1,2	
	Output LF Current Ripple(<120Hz)		5%	10%	20MHz BW, Full load output Ripple Index is defined as [(Ymax-Ymin)/(Ymax+Ymin)] * 100%. Y may be V or I	
	Line Regulation	-2%		+2%	Measured at 120, 230, 277 Vac / 60Hz Input, Output Full Load	
	Load Regulation	-5%		+5%	Measured at 120, 230, 277 Vac / 60Hz Input	
	Start-up Time				500ms	Measured at 120, 230 Vac / 60Hz Input, Output Full Load
					450ms	Measured at 277 Vac / 50Hz Input, Output Full Load
	Output Overshoot	-2%		+10%	Measured at 120, 230, 277 Vac Input, When power on or off	
Hold-up Time		10ms		Typical @ 277 Vac Input, Output Full Load		

Product datasheet

Technical data

Electrical Specifications

Protection	Input undervoltage protection	Protection voltage	70V	90V	The input voltage is lower than the protection voltage, and the output is turned off
		Recovery voltage	75V	95V	Self recovery mode. The input voltage is higher than the recovery voltage, and the driver restarts
		Output Short Circuit (SCP)			No Damage. Auto recovery after short is removed
		Output Over Current (OCP)		+10% I _o	Constant Current Limiting circuit
		Output Over Voltage (OVP)		120% V _o	No Damage. Auto recovery after short is removed
General	Cooling	Convection			
	MTBF	480,000 hours		Measured at 230 Vac input, 100% Load and Tc=25°C	
	Life Time	50,000 hours		@ Tc = 80°C	
Environmental	Case Temperature (Tc)	-30 °C		+90 °C	Measured at location specified on case
	Operating Temperature (Ta)	-30 °C		+50 °C	This is a reference range. Tc controls temperature range
	Storage Temperature (Ts)	-40 °C		+85 °C	Non operating temperature range
	Operating Humidity	5% RH		95% RH	Relative Humidity. Non-condensing
	Vibration	5 Hz		55 Hz	2G, 10 minutes / 1 cycle, period 30 minutes, each along X, Y, Z axis

	Parameter	Min	Typ	Max	Notes / Conditions	
Dimming	0-10V Dimming	Input Absolute Voltage	-2.0V	10V	15V	Purple Wire
		Output Source Current	200uA	300uA	450uA	Purple Wire
		Output Current Range in 0-10V Dimming	10%		100%	CCR output
		V _{dim} @ Maximum Output Current	8.6V	8.8V	9.0V	
		V _{dim} @ Minimum Output Current	1.2V		1.6V	
	PWM Dimming	Input Absolute Voltage	-2.0V	10V	15V	
		Input Current on PWM pin	200uA	300uA	450uA	
		PWM Frequency	200Hz	1KHz	1.5KHz	
		PWM Duty	0%		100%	
		Output Current Range in PWM Dimming	10%		100%	CCR output
		Output Current in PWM Pin Open		Normal	15V	
		Output Current in PWM Pin Short Circuit		Min	1000uA	

Product datasheet

Technical data

Electrical Specifications

	Category	Standards / Notes	
Safety Compliance	UL / cUL	UL8750, UL1310 Class 2, UL1012 Non Class 2, CSA-C22.2 No. 107.1	
	CCC	GB19510.14-2009, GB19510.1-2009	
	ENEC & CE	EN 61347-1:2007+A1:2010+A2:2012, EN61347-2-13:2014 EN 62493:15	
	Withstand Voltage	Input to Output: 2000 Vac (UL), 3750 Vac (CE, TUV, ENEC); PE to Input:1500 Vac; Dim to Input: 2500 Vac, Dim to Output: 2500 Vac	
	Isolation Resistance	Input to Output: >10MΩ, 500Vdc @ 25°C, 70% RH	
	Dimming	DIM+ (Purple) / DIM- (Pink) are Class 2 Isolated from AC Input and DC Output	
EMC Compliance	FCC	FCC 47CFR Part 15, Class B, ANSI C63.4: 2009	
	CCC	GB17743-2007, GB17625.1-2012	
	EMI	CE	EN55015:2013+A1:2015 EN 61000-3-2:2014, EN 61000-3-3:2013
		Energy Star	Energy Star transient protection: Ballast or driver shall comply with ANSI/IEEE C62.41.1-2002 and ANSI/IEEE C62.41.2-2002, Category A operation. The line transient shall consist of seven strikes of a 100KHZ ring wave,2.5KV level, for both common mode and differential mode
	EMS	EN 61000-4-2	Electrostatic Discharge (ESD): 8KV air discharge, 4KV contact discharge
		EN 61000-4-3	Radio-Frequency Electromagnetic Field Susceptibility Test-RS
		EN 61000-4-4	Electrical Fast Transient / Burst-EFT
		EN 61000-4-5	Surge Immunity Test: AC Power Line: line to line 6KV, line to earth 10KV
		EN 61000-4-6	Conducted Radio Frequency Disturbances Test-CS
		EN 61547	Electromagnetic Immunity Requirements Applies To Lighting Equipment

Note: The above test data are in the condition of 25 °C ambient temperature, except for the marked temperature

Typical Applications

LED Forward voltage: $V_F = 3.0V \sim 3.5V$

Constant Current Driver

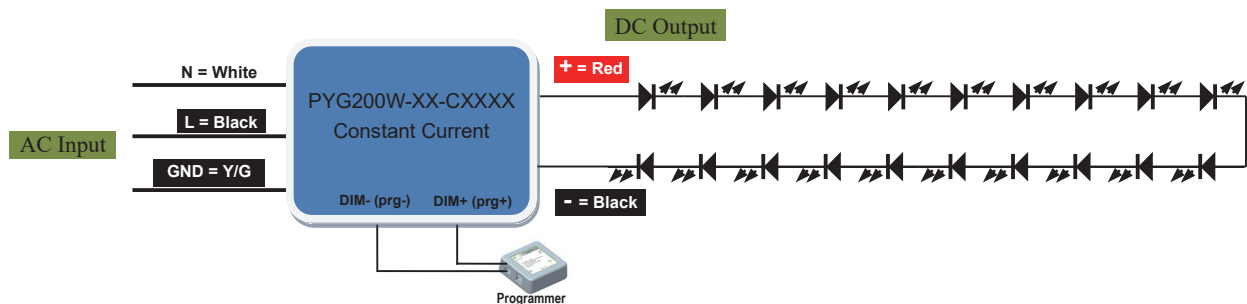

Product datasheet

Appearance information

Note: The following is the EU size drawing

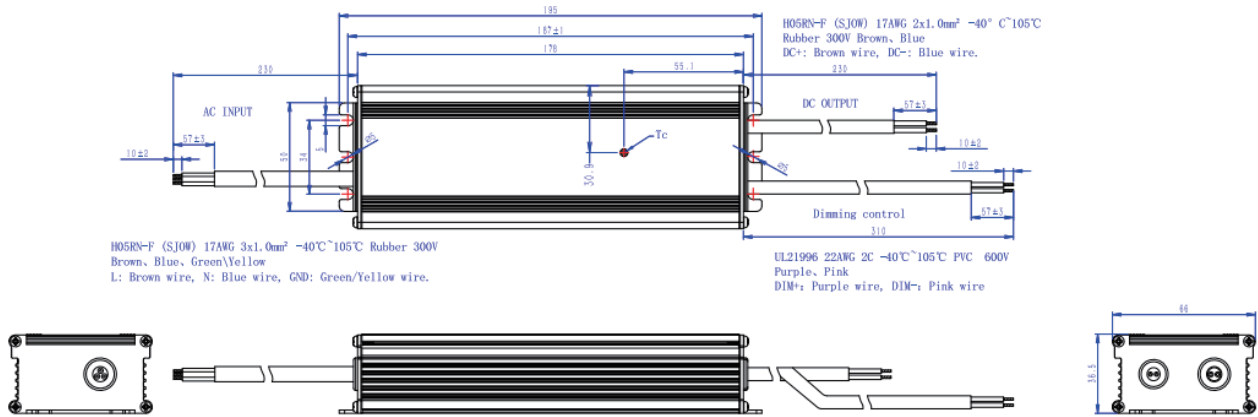

Note:

The independent LED drive conforms to the EMC standard. But it is not guaranteed to be qualified, when the drive is mounted in the LED fixture
 Please forgive us for any discrepancy due to the update of the specifications or the upgrade of the product. If you need the latest information, please contact our marketing department

Dimming Curve

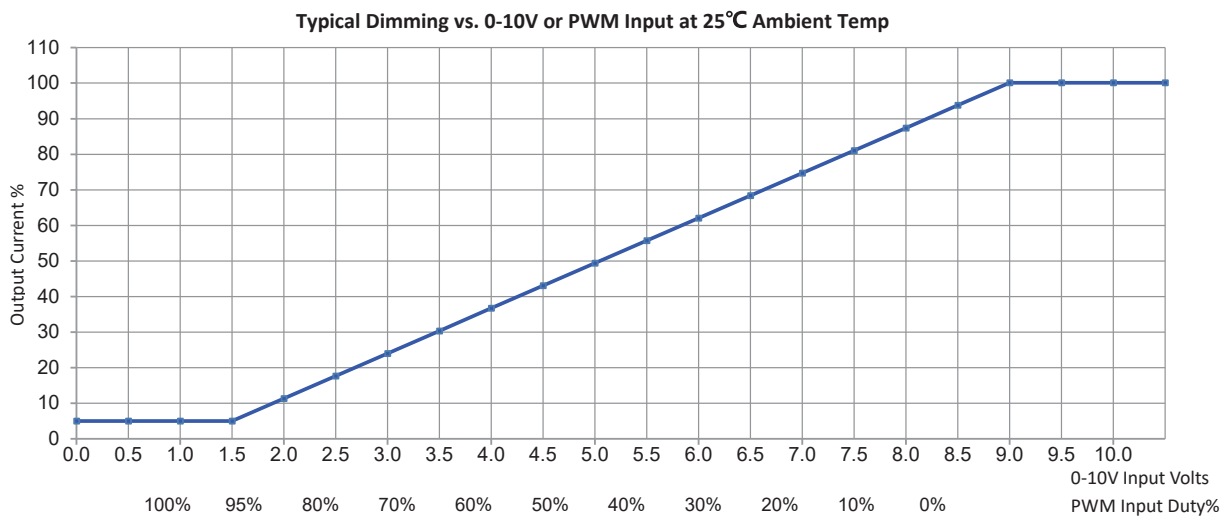

Product datasheet

Characteristic Curve

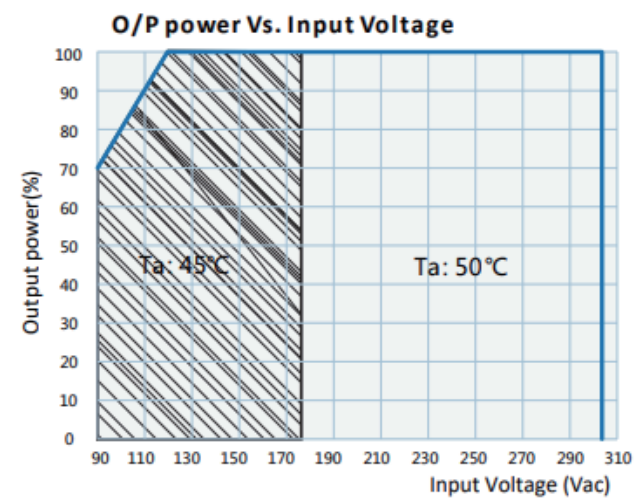
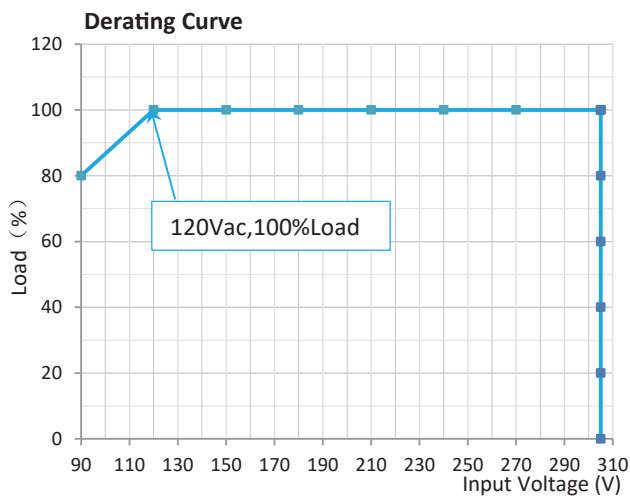
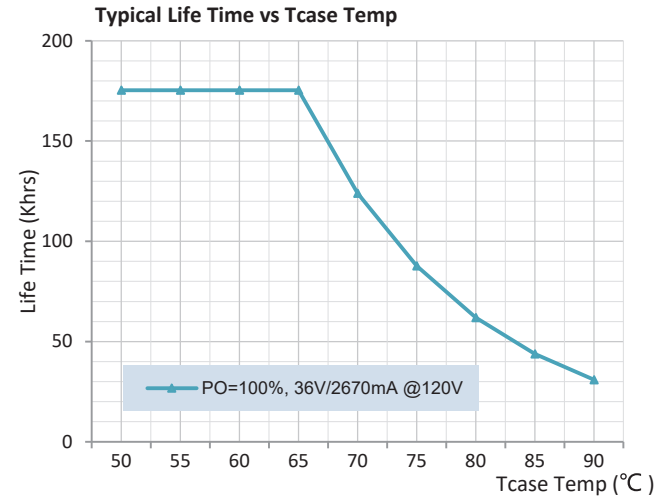
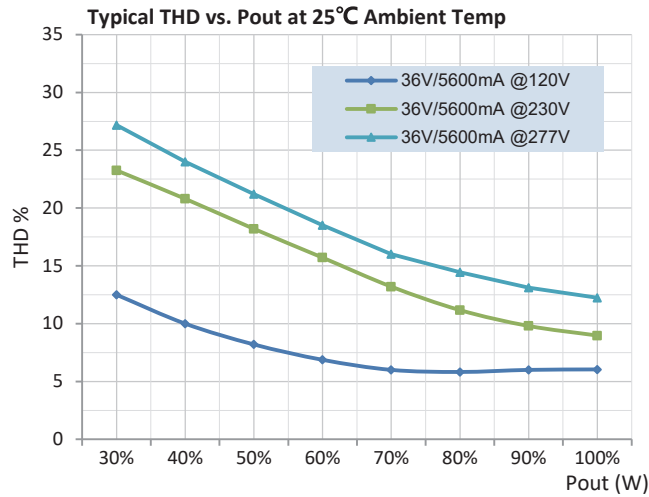
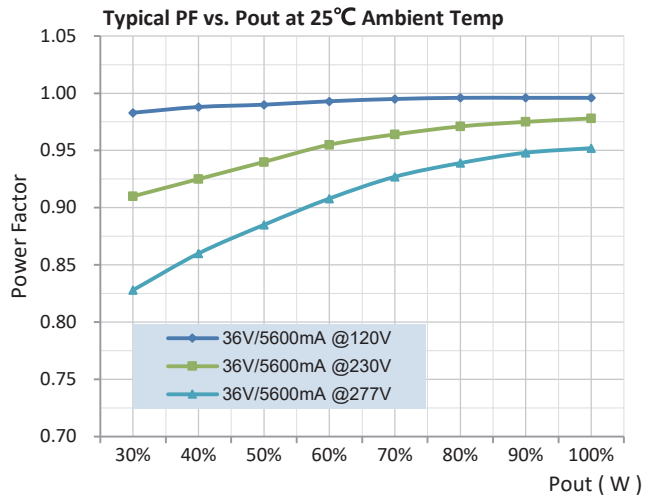
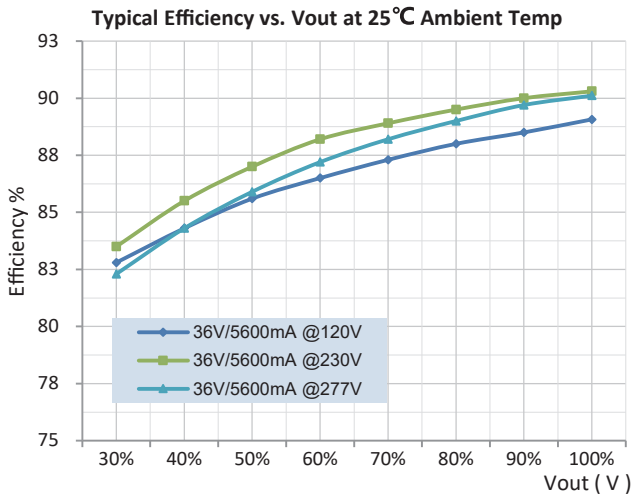

Product datasheet

Operating Window (PYG200W-56-C5600)

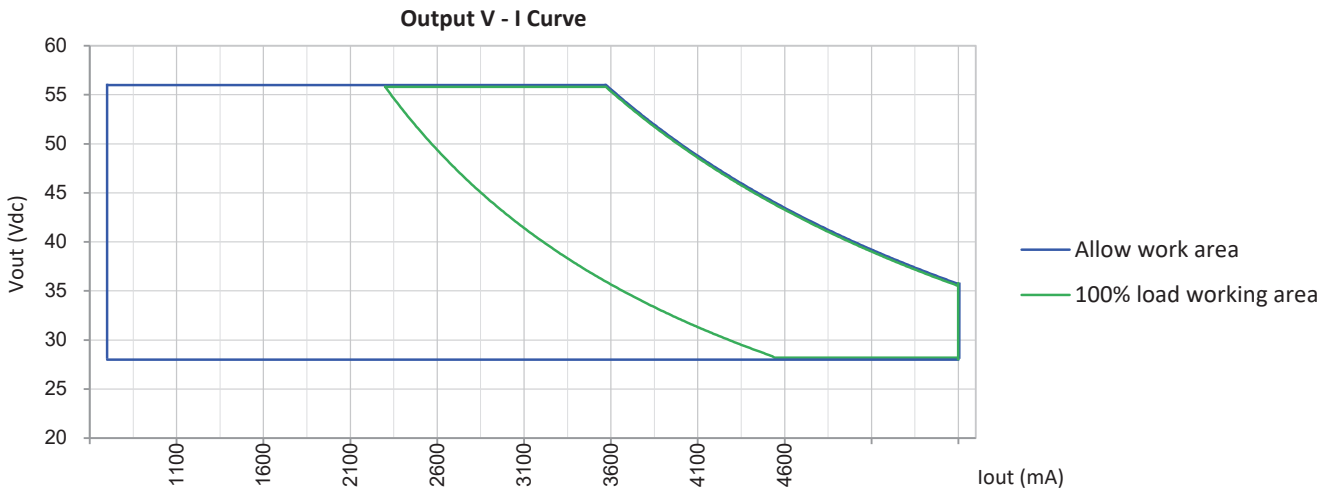

Operating Window (PYG200W-150-C2100)

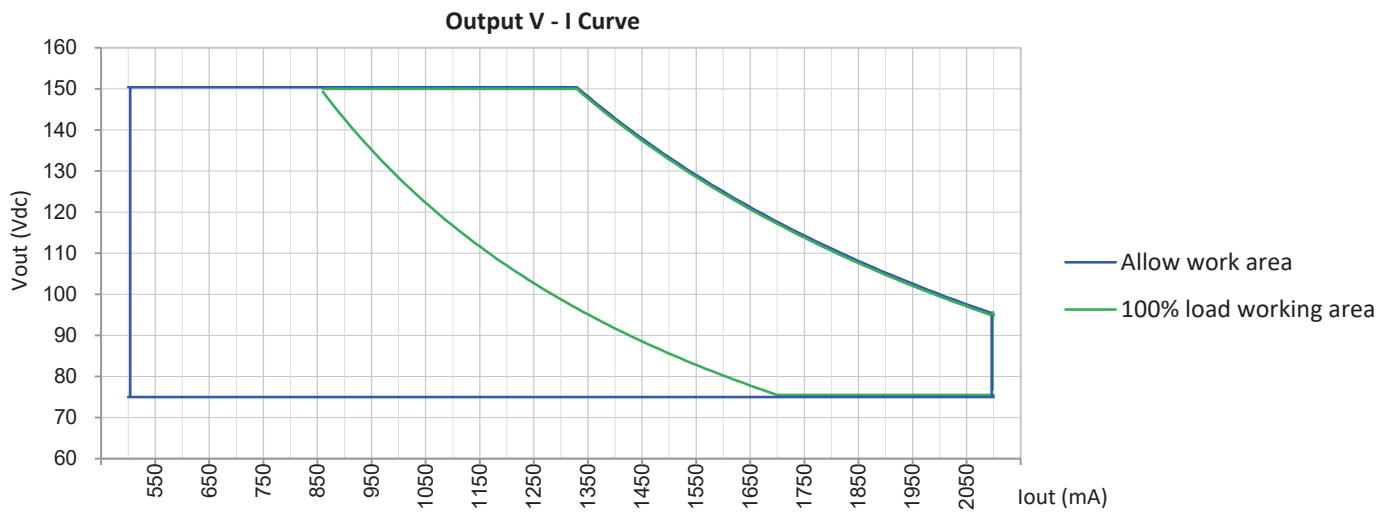

Product datasheet

Operating Window (PYG100W-107-C1400)

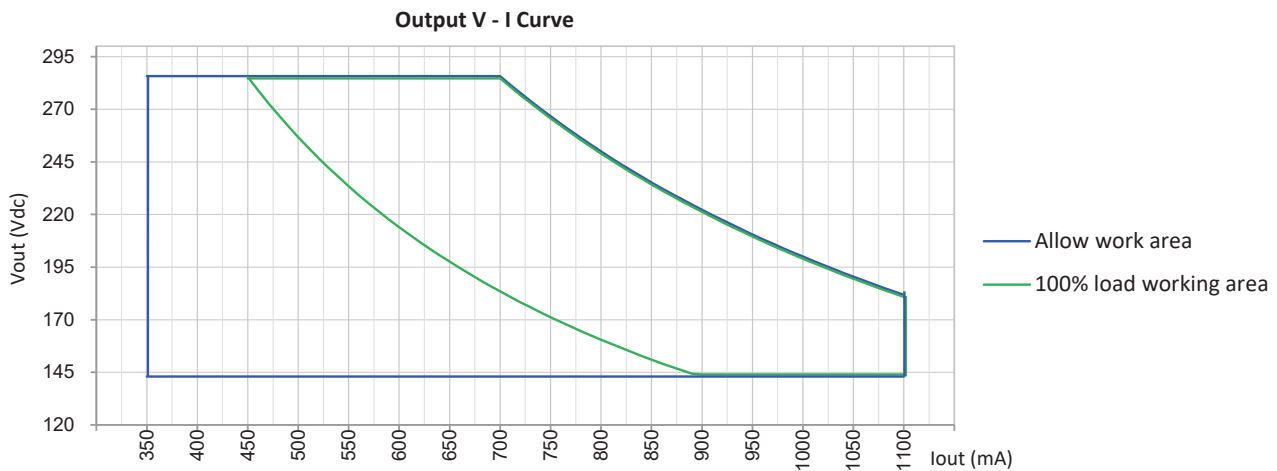

Installation

UL Cable used in Dry & Damp Location:

AC input cable, the three cores, ANSI/UL2733 18AWG 3C -40°C ~105°C PVC 600V Black、 White、 Green\Yellow
Cable Length: 230mm, External stripping 57mm, Stripping on the tin: 10mm.
Where: L — Black wire, N — White wire, GND — Green\Yellow wire

DC output cable, the two cores, ANSI/UL2733 18AWG 2C -40°C ~105°C PVC 600V Red、 Blue
Cable Length: 230mm, External stripping 57mm, Stripping on the tin: 10mm.
Where: DC+ — Red wire, DC- — Blue wire

Dimming control cable, the two cores, ANSI/UL2733 22AWG 2C -40°C ~105°C PVC 600V Purple、 Pink
Cable Length: 310mm, External stripping 57mm, Stripping on the tin: 10mm.
Where: DIM+ (0-10V or PWM) input — Purple wire, DIM- — Pink wire

UL & CE, CCC, ENEC Standard used in Wet Location:

AC input for connection the three cores copper wire connection.
Outdoor Type: IEC 60245 /VDE 0282-4 / H05RN-F (SJOW) 17AWG 3x1.0mm² -40°C~105°C Rubber 300V Brown、 Blue、 Green\Yellow
Cable Length: 230mm, stripping on the tin: 10mm.
Where: L — Brown wire, N — Blue wire, GND — Yellow/Green wire

DC output for connection the two core copper wire.
Outdoor Type: IEC 60245 /VDE 0282-4 / H05RN-F (SJOW) 17AWG 2x1.0mm² -40°C~105 °C Rubber 300V Brown、 Blue

Cable Length: 230mm, stripping on the tin: 10mm.
Where: DC+ — Brown wire, DC- — Blue wire

The dimmer control input is the two copper wires. ANSI/UL21996 22AWG 2C -40°C ~105°C PVC 300V Purple、 Pink
Cable Length: 310mm, stripping on the tin: 10mm.
Where: DIM+ (0-10V or PWM) input — Purple wire, DIM- — Pink wire