

P/N: FAPL10VH-182Y2R0

RoHS

Outline Dimensions (Unit:mm)

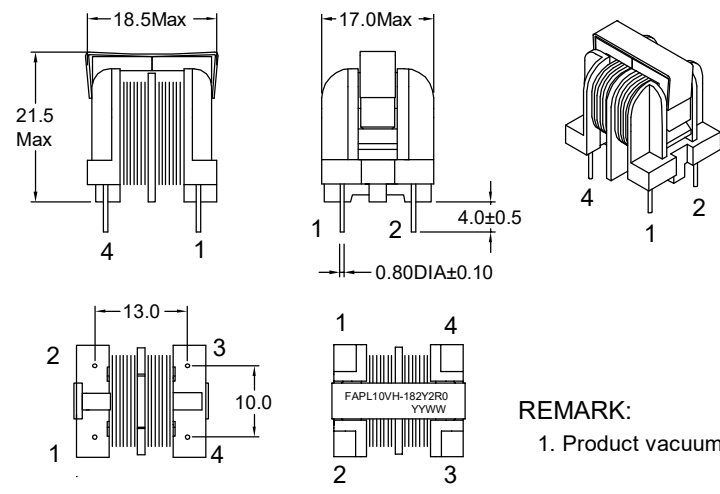

REMARK:  
1. Product vacuum impregnation.

Electrical Characteristics

Inductance : 1.80mH Min,at 10KHz,0.1V.  
 Rated current : 2.0Amps.  
 D.C.Resistance : 0.12 ohms Max.  
 Turns Ratio : Wdg1:Wdg2=1:1±1%,at 20KHz,1V.  
 Hipot : Coil-Coil : 1500VAC/3mA/2S.

General Properties:

Operating Temperature:-40°C to +125°C  
 (Temperature rise included).  
 Storage Temperature:-25°C to +85°C.  
 Storage Humidity:RH10%~70%.  
 Weight: ≈10.0g

Current VS Temp.(Simulation test).

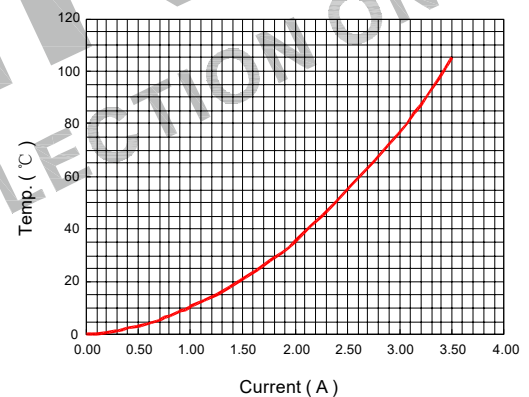

Electronical Schematic

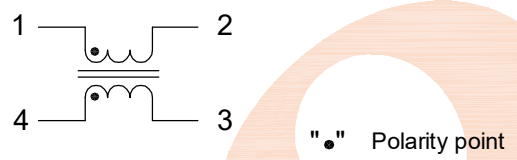

Winding Construction:

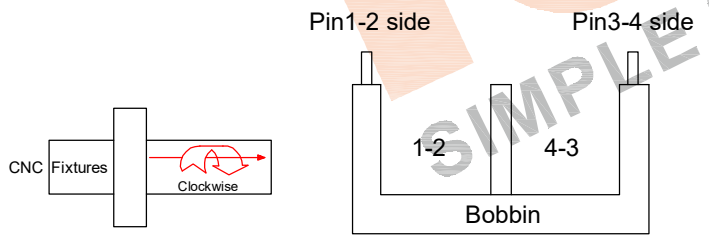

List of UL Certificate:

No.	Part Name	Mat'l Description	Supplier	UL Number
1	Bobbin	UU-1052/T375J	Chang Chun Plastics Co Ltd	E59481
2	Copper wire	2UEW-F/155C	Dong Guan YiDa Industrial Co Ltd	E344055
3	Core	UU10.5-H10K	Fuan	N/A
4	Clip	UU10.5/SUS301	Chuangshun Hardware Electronic Factory	N/A
5	Varnish	T-4260(a)/MW80-C	SuZhou TaiHu Electric Advanced Material Co Ltd	E228349

				Tianchang Fuan Electronic Co Ltd www.fuantronics.net TEL: +86-550-7814888 FAX: +86-550-7831133		Make: <i>Jun</i> Checked: <i>BenSon</i> Approved: <i>AmSon</i>		<b>DRAWING TITLE</b> UU10.5 COMMON-CODE FILTER INDUCTOR Material Number: A24PL10XA290		Customer P/N: Document/Rev: 2201067/00 Specification Sheet: 1 of 1 Date of Recognition: Jan./02/2021	
REV	DESCRIPTION	APPD	DATE			Tolerances unless otherwise specified: (X)±0.50 (XX)±0.25 Unit of measurement: mm					