

P/N: FAT74023

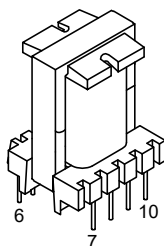

Outline Dimensions(Unit:mm)

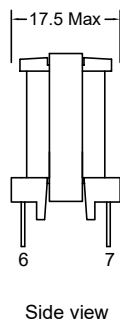
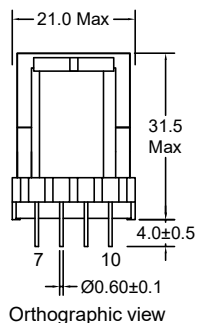

Stereogram

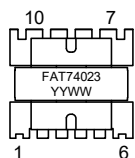

Top view

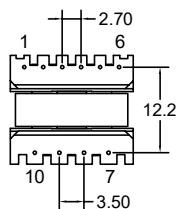

Bottom view

REMARK:

1. Fixed Core With 2Ts Tape.
2. Product vacuum impregnation.

Electrical Schematic

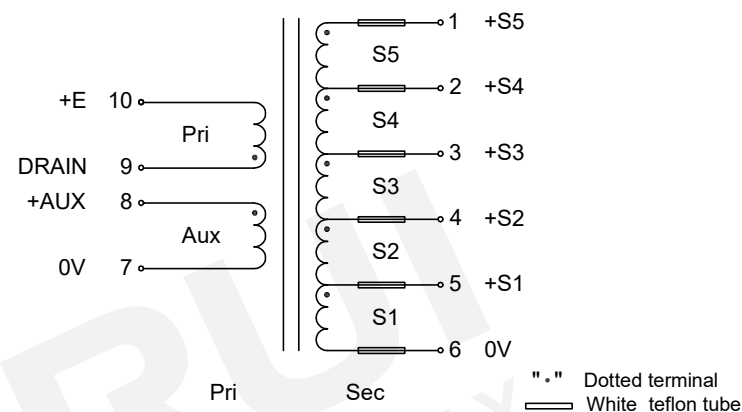

General Properties:

- Operating Temperature:-40°C to +105°C.
- Storage Temperature:-25°C to +85°C.
- Insulation Class:B.

Wave Soldering

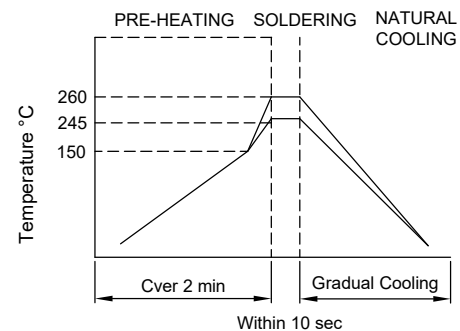

Note:

- 1.Never Contact the ceramic with the iron tip:
- 2.1.0mm tip diameter(max).

Electrical Characteristics

Inductance : L9-10= 1.25mH ±10%,at 1KHz,0.3V.

D.C.Resistance : 1-2= 0.174 ohms Max.

2-3= 0.042 ohms Max.

3-4= 0.056 ohms Max.

4-5= 0.007 ohms Max.

5-6= 0.010 ohms Max.

8-7= 0.502 ohms Max.

9-10= 1.559 ohms Max.

Turns Ratio : Pri:Aux:S1:S2:S3:S4:S5=120:17:4:2:8:6:13±2%,at 20KHz,1V.

Hipot : Pri-Sec : 4000VAC/5mA/2S.

Pri&Sec-Core : 1500VAC/5mA/2S.

Pri-Aux : 1500VAC/5mA/2S.

Tianchang Fuan Electronic Co Ltd
www.fuantronics.net
TEL: +86-550-7814888
FAX:+86-550-7831133

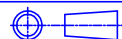

Tolerances unless otherwise specified:
(.X)±0.50 (XX)±0.25
Unit of measurement: mm

Make: Qiumei.Liu
Checked: Beson. zhan
Approved: Anson. zhan

DRAWING TITLE
EL19 FLYBACK TRANSFORMER
Material Number: A2174023S000

Customer P/N:
Document/Rev: 00
Specification Sheet: 1 of 2
Date of Recognition: Jan./02/2020

REV	DESCRIPTION	APPD	DATE

P/N: FAT74023



List of UL Certificate:

No.	Part Name	Mat'l Description	Supplier	UL Number
1	Bobbin	PY-1922/PM9630/FAY01041	Sumitomo Bakelite Co Ltd	E41429
2	Copper wire	2UEW-F/155C	Dong Guan YiDa Industrial Co Ltd	E344055
		2UEW-F/155C	Elektrisola Hangzhou Co Ltd	E258243
3	Core	EE19/13/5 HPP4	Anhui Hualin Magnetic Technology Go Ltd	N/A
		EE19/13/5 GP4	Su Zhou Guanda Magnet Co Ltd	N/A
4	Tape	JY25-A(b)/130C(Faint Yellow)	Jingjiang Jingyi Adhesive Product Co Ltd	E246950
		CT (b)(g)/130C(Faint Yellow)	JingJiang Yahua Pressure Sensitive Glue Co Ltd	E165111
5	Margin tape	WF310(a)/130C	Jingjiang Jingyi Adhesive Product Co Ltd	E246950
		WF* (c)(h)/130C	JingJiang Yahua Pressure Sensitive Glue Co Ltd	E165111
6	Tube	CB-TT-L/200°C	ChangYuan Electronics Group Co Ltd	E180908
		CB-TFL/200°C	Dongguan City Changjie Metals & Plastic Products Co Ltd	E338209
7	Varnish	T-4260(a)/MW80-C	SuZhou TaiHu Electric Advanced Material Co Ltd	E228349

Label:

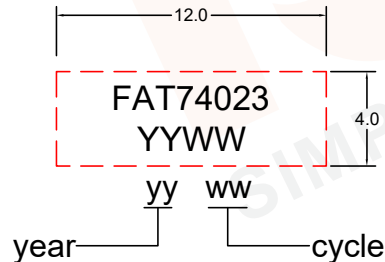

Remark:

- 1.Use Laser printing;
- 2.Clear writing and legibility, not easy to erase;
- 3.Border here means size range, not be printed;
- 4.Font:Arial;Height:1.20mm.

				Tianchang Fuan Electronic Co Ltd www.fuantronics.net TEL: +86-550-7814888 FAX: +86-550-7831133	 Tolerances unless otherwise specified: (.X)±0.50 (XX)±0.25 Unit of measurement: mm	Make: Qiumei.Liu Checked: Beson. zhan Approved: Anson. zhan	DRAWING TITLE EL19 FLYBACK TRANSFORMER Material Number: A2174023S000	Customer P/N: Document/Rev: 00 Specification Sheet: 2 of 2 Date of Recognition: Jan./02/2020
REV	DESCRIPTION	APPD	DATE					